



Magnum 4K-Series 4K16 Switches



Installation and User Guide

Magnum™ 4K-Series

4K16 Switches

Installation and User Guide

Part #: 84-000081 (Rev E)

Trademarks

Ethernet is a trademark of Xerox Corporation

NEBS is a trademark of Telcordia Technologies

UL is a registered trademark of Underwriters Laboratories

GarrettCom, Magnum and Personal Switch are trademarks and **Personal Hub** is a registered trademark of GarrettCom, Inc.

Important: The Magnum 4K16 Switches contains no user serviceable parts. Attempted service by unauthorized personnel shall render all warranties null and void. If problems are experienced with the Magnum 4K16 Switches, consult Section 6, Troubleshooting, of this User Guide.

Copyright © 2005 GarrettCom, Inc. All rights reserved. No part of this publication may be reproduced without prior written permission from GarrettCom, Inc.

Printed in the United States of America.

Contacting GarrettCom, Inc

Please use the mailing address, phone and fax numbers and email address listed below.

GarrettCom, Inc.
47823 Westinghouse Dr.
Fremont, CA 94539
Phone (510) 438-9071
Fax (510) 438-9072

Website: <http://www.GarrettCom.com>

email support@garrettcom.com

Federal Communications Commission**Radio Frequency Interference Statement**

Warning: Changes or modifications to this unit not expressly approved by the party responsible for compliance could void the user's authority to operate the equipment.

NOTE: This equipment has been tested and found to comply with the limits for a class B digital device, pursuant to part 15 of the FCC Rules. These limits are designed to provide reasonable protection against harmful interference in a residential installation. This equipment generates, uses, and can radiate radio frequency energy and, if not installed and used in accordance with the instructions, may cause harmful interference in a residential installation. This equipment generates, uses, and can radiate frequency energy and, if not installed and used in accordance with the instructions, may cause harmful interference to radio communications. However, there is no guarantee that interference to radio communications. However, there is no guarantee that interference will not occur in a particular installation. If this equipment does cause harmful interference to radio or television reception, which can be determined by turning the equipment off and on, the user is encouraged to try to correct the interference by one or more of the following measures.

- ***Reorient or relocate the receiving antenna.***
- ***Increase the separation between the equipment and receiver.***
- ***Connect the equipment into n outlet on a circuit different from that to which the receiver is connected.***
- ***Consult the dealer or an experienced radio TV technician for help.***

Canadian Emission

This Class B digital apparatus meets all requirements of the Canadian Interference-Causing Equipment Regulations.

Cet appareil respecte toutes les exigences du Règlement sur le matériel du Canada. Cet appareil est Classe B.

TABLE OF CONTENTS**Page**

1.0	SPECIFICATIONS	1
1.1	Technical Specifications	1
1.2	Ordering Information	3
2.0	INTRODUCTION	4
2.1	Inspecting the Package and Product	4
2.2	Product Description - Magnum 4K16 Switches	5
2.2.1	Magnum 4K16F Switch chassis	5
2.2.2:	Magnum 4K16R “Reverse” model, front LEDs and connections in rear	6
2.2.3	Fiber-port module (FKM) options for 4K16’s and 4K16R’s, 100Mb fiber	7
2.2.4	4K16, 10/100 Dual-speed switched ports, RJ-45 (copper only)	8
2.2.5	Up-link Switch at port#1 for Cascading	9
2.2.6	Frame Buffering and Latency	9
2.3	Features and Benefits	11
2.4	Applications	12
3.0	INSTALLATION	14
3.1	Locating Magnum 4K16 Switches	14
3.2	Connecting Ethernet Media	15
3.2.1	Connecting Fiber Optic <u>ST-type</u> , “twist-lock”	15
3.2.2	Connecting Fiber Optic <u>SC-type</u> , “Snap-In”	16
3.2.3	Connecting <u>Single-Mode</u> Fiber Optic	16
3.2.4	Connecting <u>MTRJ</u> Fiber Optic “Snap-In”	16
3.2.5	Connecting Twisted Pair (RJ-45,CAT3, CAT5, Unshielded)	16
3.3	Rack-mounting	17
4.0	OPERATION	18
4.1	Switching Functionality	18
4.2	Status LEDs	19
4.3	Up-link Switch, for RJ-45 Port#1 only	19
4.4	Auto-negotiation, for Fast Ethernet copper ports	19
4.5	Auto-negotiation full-duplex mode	20
4.6	Flow-control, IEEE 802.3x standard	21
4.7	Power Budget Calculations for 4K-Series FKM’s with Fiber Media	21
5.0	INTRODUCTION - MAGNUM 4K16 FIBER-PORT MODULES (FKM)	23
5.1	Product Description	23
5.1.1	FKM-MST, 100Mbps multi-mode FX-ST-type, “twist-lock” connector	23
5.1.2	FKM-MSC 100Mbps multi-mode FX-SC-type, “snap-in” connector	23
5.1.3	FKM-SSC and -SSCL 100Mbps <u>single-mode</u> FX-SC-type, “snap-in”	23
5.1.4	FKM-MTRJ, 100Mb multi-mode FX, <u>MTRJ small-form-factor</u>	24
5.1.5	FKM-Blank	24
6.0	TROUBLESHOOTING	25
6.1	Before Calling for Assistance	25
6.2	When Calling for Assistance	26
6.3	Return Material Authorization (RMA) Procedure	Error! Bookmark not defined.
6.4	Shipping and Packaging Information	27
APPENDIX A: WARRANTY INFORMATION		27
APPENDIX B : INTERNAL DC POWER SUPPLY OPTIONS		28
APPENDIX C: INTERNAL DC DUAL-SOURCE POWER OPTION		30

Revisions

12/05 : Updated the specifications and minor updates.

10/04: Edited minor change

04/03: Edited minor change

Rev E 04/02 : Updated Rack-mounting, Appendix B & C with 24VDC and 125VDC addition

Rev D 01/02 : Updated Operating Environment Spec.

Rev C 04/01: Change the company name to GarrettCom, Inc. (Formerly it was Garrett Communications). There are no changes to the content of the material at this time.

Rev B 12/00 : Addition of Warnings in the French Language.

Rev A 04/00 : This revision is the initial release of the 4K16 Switch user manual.

The Magnum Line

ETHERNET CONNECTIVITY PRODUCTS
"DESIGNED AND MANUFACTURED IN THE USA"

OVERVIEW

GarrettCom, Inc. offers the premium-quality Magnum™ line of Ethernet LAN connectivity products with industry-standard functionality and built-in fiber configurability. Magnum products are designed for use in demanding Carrier Class, Industrial Grade and OEM applications where reliability is a primary consideration.

6K25 Managed Fiber Switches, Gigabit, 100 and 10 Mbps, fiber and copper ports, mix-and match. Features SFF fiber for up to 25 fiber ports in a 1U unit.

4K-Series Switches, 100 and 10 Mbps, copper ports with optional fiber port, with auto-negotiating full switching performance.

Quad-Series Fiber Switches, 100 & 10Mbps, fiber and copper ports, mixed-speed and mixed-media types, full switching performance.

“Outdoor” Ethernet Switch, for temperature uncontrolled locations

6 10/100 and 2 100Mb fiber ports, can be connected in strings

Mixed-Media Fiber Hub, 16-port Stackable, 10/100 auto-sensing

Dual Speed 8-port and 16-port Stackables, 10/100 auto-sensing

Stackable Hubs, SNMP Optional

10Mb series and 100Mb series, both w/ optional port modules

Personal Switches, 10/100Mb

8 port dual speed, Auto-negotiable with fiber option

Personal Hubs, 100Mb or 10/100Mb

8-port, with two switched ports (1 fiber built in)

Personal Hubs, 10Mb series

8-port + AUI, stackable to 5 high, + optional BNC of fiber port

8 or 9-port and 4 or 5-Port Personal Hubs, w/ man. up-link sw.

Media Converters, 10Mb and 100Mb series

All media combinations, incl. fiber ST, SC, mm., single mode

The “X-line” of configurable MiXed Media products:

Stackable Concentrators, SNMP optional, 13-Ports

Mini-Concentrators, 7 Ports, Repeaters, 2-Ports

Repeater Port Modules (RPMs), 6 types for Ethernet media

Bridge Port Modules (BPMs), 4 types, for segment isolation

Transceivers, 10Mb series Mini-Transceivers and Coax Models

Dec., 05

1.0 SPECIFICATIONS**1.1 Technical Specifications****Performance**

Data Rate:	10 Mbps or 100MB, per port
Aggregate Forwarding Rate:	(all ports are wire speed)
	2.38M frames/sec for 16 100Mbps ports (for Magnum 4K16)
	2.68M frames/sec for 16 100Mbps ports & two fiber ports
	(16RJ-45 +2 Fiber ports)
Aggregate Filtering Rate:	(all ports are wire speed)
	2.38M pps for all 16 ports
	2.38M pps for all 18 ports (16 RJ-45 ports+ 2 Fiber ports)
Address Table Capacity:	4K node addresses, self-learning w/address aging
Packet buffer size :	512K dynamic
Latency:	5 μ s + packet time (100 to 100Mbps)
	15 μ s + packet time (10 to 10 Mbps, and 10 to 100Mbps)

Network Standards

Ethernet V1.0/V2.0 IEEE 802.3: 10BASE-T,
IEEE 802.3u: 100BASE-TX, 100BASE-FX

Maximum 10 Mbps Ethernet Segment Lengths

Unshielded twisted pair, Cat 3 - 100 m (328 ft)
10BASE-FL multi-mode fiber optic - 2 km (6,562 ft)
10BASE-FL single-mode fiber optic - 10 km (32,810 ft)

Maximum Standard Fast Ethernet Segment Lengths:

10BASE-T (CAT 3, 4, 5 UTP) - 100 m (328 ft)
100BASE-TX (CAT 5 UTP) - 100 m (328 ft)
100BASE-FX, half-duplex, multi-mode - 412 m (1350 ft)
100BASE-FX, full-duplex, multi-mode - 2.0 km (6,562 ft)

100BASE-FX, half-duplex, single-mode - 412 m (1350 ft)
100BASE-FX, full-duplex, single-mode - 20.0 km (49,215 ft)
100BASE-FX, full-duplex, s.m(Long Reach)- 40.0 km (132,215 ft)

Connectors for copper wiring

Twisted Pair at 10/100Mb:RJ-45 shielded, female, front mounted
(for Magnum 4K-Series Fast Ethernet copper ports, use Cat 5 cable)

Fiber Multi-mode connector types:

Fiber Port, SC-type (snap-in): Fiber optic multi-mode, 100BASE-FX
Fiber Port, ST-type (twist-lock): Fiber optic multi-mode, 100BASE-FX
Fiber Port, MTRJ-type (plug-in): Fiber optic multi-mode, 100BASE-FX

Fiber Single-mode connector types:

Fiber Port, SC-type: Fiber optic single-mode, 100BASE-FX
Fiber Port, SC-type: Fiber optic "long-reach" single-mode, 100BASE-FX

Manual switch-selections and jumpers

Fiber default: 100Mbps Full-duplex, F/H (Full/ Half duplex switch settings)

Copper default: Auto-negotiation (Up-link switch for cascading at port #1, (=) for normal port and (X) for an upstream cascaded hub or switch)

LEDs: Per Port

L/A: Steady ON for Link enabled, blinking indicates Activity, port is transmitting and receiving

F/H: ON = Full-Duplex Mode
OFF = Half-Duplex Collision

100/10: ON = 100Mbps speed
OFF = 10 Mbps

Operating Environment

Ambient Temperature: 25° to 140° F (-5° to 60°C) optional extended range

Storage Temperature: -40° to 185°F (-40° to 85°C)

Ambient Relative Humidity: 5% to 95% (non-condensing)

Altitude: -200 to 13,000 ft. (-60 to 4000m)

Packaging

Enclosure: Rugged High strength metal. Suitable for stand-alone or rack-mounting

Dimensions: 1.75 in H x 17.0 in W x 9.0 in D
4.45cm H x 43.2cm W x 22.9cm D

Weight: 3.2 lb. (1.4 Kg) rack-mount models

Cooling method: Fan cooled, @ 7 cfm

Power Supply (Internal)

AC Power Connector: IEC-type, male recessed at rear of chassis, with adjacent manual ON-OFF switch (on AC models only)

Input Voltage: 110 to 240 VAC (auto-ranging)

Input Frequency: 47 to 63 Hz (auto-ranging)

Power Consumption: 17 watts typical, 25 watts max.

DC Power Supply (Options)

-48VDC Power Input Voltage : 36 to 72 VDC

24VDC Power Input Voltage : 20 to 36VDC

125VDC Power Input Voltage : 120 to 160VDC

Std. Terminal Block : “ -, GND, + ”

Power Consumption: same as for AC models, see above

For Dual Source and Redundant DC for -48VDC, 24VDC Power & 125VDC supply options (Optional), see Appendices.

Agency Approvals

UL listed (UL1950), cUL, CE

Emissions meet FCC Part 15 Class B

Optional: ETSI and NEBS L3 Certified

Warranty

Three years, return to factory

Made in USA

1.2 Ordering Information**Magnum 4K16 Switches****MODEL****DESCRIPTION****Magnum 4K16**

Ethernet Switch with 16 RJ-45 ports, each auto-sensing for 10Mbps/10Mbps FDX/HDX operation. Optional fiber port may be configured one or two from the family of modules below and added another two ports Maxm. User selected fiber port connector types. Each port is switched and provides a full-speed traffic domain with non-blocking performance. Includes internal auto-ranging power supply, cooling fan, and metal brackets for rack-mounting. LEDs and user ports are in the front, power inputs is in the rear. Units with -48V power supply options available RFQ for 120VDC power option.

Magnum 4K16R

“Reverse” model, Same as Model 4K16 Switch except user ports and the power input connectors are in the rear. LEDs are in the front.

Fiber port modules for Magnum 4K-Series (Models 4K16F):**FKM-2SC**

Fiber module with two 100Mbps multi-mode FX SC connectors

FKM-2ST

Fiber module with two 100Mbps multi-mode FX ST connectors

FKM-2MTRJ

Fiber module with two 100Mbps multi-mode FX “MTRJ” connectors

FKM-2SSC

Fiber module with two 100Mbps 20Km single-mode FX SC connectors

FKM-2SSCL

Fiber module with two 100Mbps 40 Km “long-reach” single-mode FX SC connectors

FKM-1MTRJ

Fiber module for 4K-Series Switches, with one 100Mbps multi-mode FX “MTRJ” connectors

FKM-1SSC

Fiber module with one 100Mbps 20Km single-mode FX SC connectors

FKM-1SSCL

Fiber module with one 100Mbps 40 Km “long-reach” single-mode FX SC connectors

FKM-BLNK

Blank face plate, included in 4K16 switch unit when no fiber port option is selected

See appendices B and C for information on DC-powered models and options.

GarrettCom, Inc. reserves the right to change specifications, performance characteristics and/or model offerings without notice.

2.0 Introduction

2.1 Inspecting the Package and Product

Examine the shipping container for obvious damage prior to installing this product; notify the carrier of any damage that you believe occurred during shipment or delivery. Inspect the contents of this package for any signs of damage and ensure that the items listed below are included.

This package should contain:

- 1 Magnum 4K16(standard) or 4K16-R(reverse-mount) Switches
- 1 AC Power Cord (U.S. and other 115 VAC only)
- 1 Set of metal “Ears” for rack mounting
- 1 Installation and User Guide (this manual)
- 1 Product Registration Card

Remove the items from the shipping container. Be sure to keep the shipping container should you need to re-ship the unit at a later date. To validate the product warranty, please complete and return the enclosed Product Registration Card to GarrettCom, Inc. as soon as possible.

In the event there are items missing or damaged, contact the party from whom you purchased the product. If the unit needs to be returned, please use the original shipping container if possible. Refer to Section 6, Troubleshooting, for specific return procedures.

2.2 Product Description - Magnum 4K16 Switches

Magnum 4K16 Switches boost the performance of medium sized Ethernet LANs, with the flexibility of both twisted-pair and fiber switched port. Fiber ports may number zero, one or two, may be configured from a variety of user selected popular fiber connector as an additional port. The Magnum 4K16 provide the switching speed and the reliability to support multiple workgroups, small offices, and departments each with its own switched 100Mbps or 10Mbps domain, for increased network performance and with “future-proof” fiber up-link ports built in.

The Magnum 16-port 4K16 Switches offer application flexibility with a series of optional fiber connector types as two additional port as (16 RJ-45+ 2 Fiber ports). All applicable fiber port connector types (100Mbps FX-ST, SC, MTRJ) along with multi-mode, single and Long-haul capability are configurable using a family of one- or two - port modules. The optional fiber ports(two maxm.) can be configured and tested with the Magnum 4K16 unit in the factory only. The rest sixteen RJ-45 ports are dual speed 10/100 Mb auto-negotiating.

Designed for use in departments, small offices with multiple workgroups, in remote offices and in network traffic centers or multi-system power users, the Magnum 4K16 Series Switches are easy to install and use. Addresses of attached nodes are automatically learned and maintained, adapting the switching services to network changes and expansions. Front-mounted LEDs provide status information on each port. The Magnum 4K-Series Switches provide high performance plug-and-play operation in convenient rack-mount packages.

The Magnum 4K16 switches are non-blocking on all ports and include 512K packet buffers and 4K-node address table for advanced performance as well as to support large networks. The Magnum 4K-Series Switches, with store-and-forward switching, filter all faulty packets to minimize traffic congestion.

2.2.1 Magnum 4K16F Switch chassis

Magnum 4K16 Series Switches come in chassis size of an 16-port rack-mountable. The optional fiber port(zero. One or two) are user selected, and 100Mbps fiber port can be configured from the popular fiber port connectors offered. The fiber-port modules are offered with factory installed only.

The 4K16 19" rack-mountable Switches comes along with 16 10/100 RJ-45 ports as a base model and have two additional fiber port(s) slot 100Mbps fiber (optional factory configured only). The total port capacity is 18 switched ports.

Figure 2.2.1a: Front view, 16-port Magnum 4K16 Series Switches

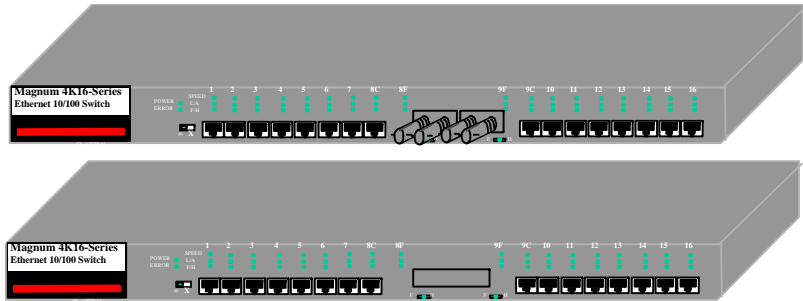

All ports, LED connector and manual switches are located on the front panel of Magnum 4K16 Series Switches. There are Full duplex/Half duplex (F/H) for fiber port, Link/Activity (L/A) and 10/100(SPEED) LED indicators for each 10Mbps and 100Mbps domain, for visual indication of the operating status of each domain. There are (POWER) and (ERROR)LEDs for indicating the power up and self test at power up failed. The IEC standard AC power connector (and a manual ON - OFF power switch) located at the rear. Fan-driven cooling air flows left to right on standard (non-reverse) models.

Figure 2.2.1b: Rear view - Magnum table-top & rack-mount 4K16C Switch

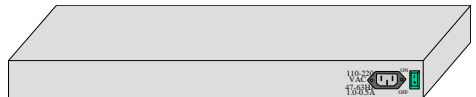

2.2.2: Magnum 4K16R “Reverse” model, front LEDs and connections in rear Front View



Rear View

The Magnum 4K16R is like the 4K16 except that the front panel has the LEDs, and all the connecting ports and power feeds are in the back. This is convenient for rack-mounting where cabling is accessed from the rear of the rack while the operating status LEDs are monitored from the front. Typically such arrangements are found in telco rack installations.

The Magnum 4K16R is dual-speed 10/100Mbps switch and has two fiber connector port options. The switching capability provides high performance support for multiple workgroups or for a power user on each port.

Normally the 4K16R is equipped with an optional internal -48VDC power supply (See Appendix A). There is an additional option of a dual-source 48V input (See Appendix B).

The DC power feed options and the high quality and versatility make the Magnum 4K16FR a good “carrier class” choice for internet infrastructure, ISPs, broadcast equipment, medical, brokerage firm and financial facilities.

2.2.3 Fiber-port module (FKM) options for 4K16’s and 4K16R’s, 100Mb fiber

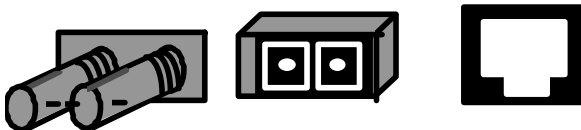

Fig.2.2.3 Fiber-Ports, FKM-ST, FKM-SC, FKM-MTRJ

The two fiber ports are optional for Magnum 4K16-series Switches. In a fiber port module, all of the fiber ports are of the same speed, the same multi- or single-mode, and the same connector type. Multi-mode 100Mbps models are available with ST, SC,

MTRJ connectors. Single-mode 100Mbps models are available with SC connectors and “Long-reach” for extra (up to 40 Km) long distance.

The 100Mb fiber port modules on the Magnum 4K16-series normally are set (factory default) to operate in full-duplex mode for best fiber distance and performance. On the Magnum 4K16 fiber series switches, the user may select full- or half-duplex mode per-port with a manual switch (F-H) located underneath the fiber ports (See Section 3.4) for the flexibility to adapt to any type of Fast Ethernet devices.

For Magnum fiber FKMs, there are LED's mounted on the front of the chassis labeled as port 8F and 9F. The Link (L/A) LED indicates ON with Link enabled, blinking for RX port activity, and F/H indicates steady for full duplex and OFF for half duplex. A fiber cable must be connected to each 100Mb port and a proper link (LK lit) must be made with the device at the other end of the cable in order for the LK LEDs to provide valid indications of operating conditions.

2.2.4 4K16, 10/100 Dual-speed switched ports, RJ-45 (copper only)

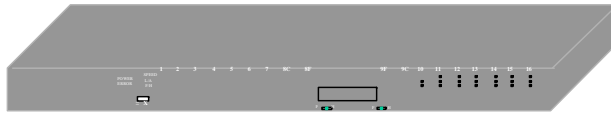

The Magnum 4K16 copper Series has 16 dual speed 10/100Mb switched RJ-45 auto-negotiating ports. The 10/100Mb switched ports are independently N-way auto-negotiating for operation at 10 or 100Mb speed in full- or half-duplex mode (as a default setting). They independently move to half-duplex mode at 10 Mb or at 100Mb speed if the device at the other end of the twisted pair cable is half-duplex or is not an auto-negotiating device.

There are three LED's for each port. The L/A (Link/Activity) steady ON for Link with no traffic and blinking indicates port is receiving and transmitting. The SPEED (10/100Mb) LED indicates operation at 100Mb speed when ON and at 10 Mb speed when OFF (when auto-negotiation is not disabled). The F/H LED is ON to indicate full-duplex operation and OFF to indicate half-duplex mode and collisions. A twisted pair cable must be connected into each RJ-45 10/100Mb port and a proper Link (LK lit) must be made with the device at the other end of the cable in order for the LEDs to provide valid indications of operating conditions.

2.2.5 Up-link Switch at port#1 for Cascading

The port#1 is equipped with a Media Dependent Interface (MDI-X) movable switch to simplify cascaded or up-link connections. It enables the first port's RJ-45 cable to either connect to a user station (=) or to be cascaded to another hub (X) with cross-over switch. (See Section 4.4 for more details about Up-link). Like all 4K16 ports, Port # 1 is a dual-speed switch port which will sense the speed of the connected device. When the Up-link port is used to cascade two Magnum 4K16 together, the auto-sensing feature will cause the connecting link to operate at 100Mb speed.

2.2.6 Frame Buffering and Latency

The Magnum 4K16 Series are store-and-forward switches. Each frame (or packet) is loaded into the Switch's memory and inspected before forwarding can occur. This technique ensures that all forwarded frames are of a valid length and have the correct CRC, i.e., are good packets. This eliminates the propagation of bad packets, enabling all of the available bandwidth to be used for valid information.

While other switching technologies such as "cut-through" or "express" impose minimal frame latency, they will also permit bad frames to propagate out to the Ethernet segments connected. The "cut-through" technique permits collision fragment frames, which are a result of late collisions, to be forwarded to add to the network traffic. Since there is no way to filter frames with a bad CRC (the entire frame must be present in order for CRC to be calculated), the result of indiscriminate cut-through forwarding is greater traffic congestion, especially at peak activity. Since collisions and bad packets are more likely when traffic is heavy, the result of store-and-forward operation is that more bandwidth is available for good packets when the traffic load is greatest.

To minimize the possibility of dropping frames on congested ports, each Magnum 4K16 Switches dynamically allocates buffer space from a 512K memory pool, ensuring that heavily used ports receive very large buffer space for packet storage. (Many other switches have their packet buffer storage space divided evenly across all ports, resulting in a small, fixed number of packets to be stored per port. When the port buffer fills up, dropped packets result.) This dynamic buffer allocation provides the capability for the maximum resources of the Magnum 4K16 unit to be applied to all traffic loads, even when the traffic activity is unbalanced across the ports. Since the traffic on an operating network is constantly varying in packet density per port and in aggregate density, the Magnum 4K16 Switches are constantly adapting internally to

provide maximum network performance with the least dropped packets.

When the Switch detects that its free buffer queue space is low, the Switch sends industry standard (full-duplex only) PAUSE packets out to the devices sending packets to cause “flow control”. This tells the sending devices to temporarily stop sending traffic, which allows a traffic catch-up to occur without dropping packets. Then, normal packet buffering and processing resumes. This flow-control sequence occurs in a small fraction of a second and is transparent to an observer. See Section 4.6 for additional details.

Another feature implemented in Magnum 4K16 Switches is a collision-based flow-control mechanism (when operating at half-duplex only). When the Switch detects that its free buffer queue space is low, the Switch prevents more frames from entering by forcing a collision signal on all receiving half-duplex ports in order to stop incoming traffic.

The latency (the time the frame spends in the Switch before it is sent along or forwarded to its destination) of the 4K16 Switches varies with the port-speed types, and the length of the frame is a variable here as it is with all store-and-forward switches. The 4K16 Switch’s latency is 5 microseconds plus the packet time at 100Mb. See Section 1.1 Specifications.

2.3 Features and Benefits

■ 100Mb switching services for high performance Ethernet LANs

Magnum 4K16 Switches provide Fast Ethernet switching on all ports. They perform high speed filter/forward operations on the traffic, giving each port's segment a full 100Mb (or 10 Mb) of bandwidth.

■ Option to configure with one or two fiber ports

Fiber port modules are available with one or two 100Mb mm-ST, SC, MTRJ or single-mode SC. The configuration flexibility of fiber ports allows 4K16 switches to adapt to mixed and changing fiber types.

■ RJ-45 (copper) ports, with N-way auto-negotiation

RJ-45 ports provide twisted pair segment connections, with N-way auto-negotiation and switching capability per port.

■ Full-duplex or Half-duplex operation, auto-sensing

All fiber and RJ-45 (copper) ports are capable of half- or full-duplex, individually selected. All RJ-45 ports support 10/100 auto-negotiation.

■ Standard (ports in front) or Reverse (ports in rear) rack mounting

The 4K16 is offered with ports and LEDs in the front, or in a "reverse" package with LEDs in front and all Ethernet and power cables in the rear. As a special feature of the 4K16 Reverse, LEDs are both front and rear. . Standard 19" rack mount brackets are included, while ETSI and 23" Telco are optional.

■ Plug-and-Play installation for high performance switching

Magnum 4K16 Switches are self-learning for node addresses. They can be placed into operation without complex set-up procedures, even in large networks. They operate transparent to system software.

■ Standard AC power input, -48VDC, 24VDC, or 125VDC is available

Standard AC power input is IEC plug, auto-ranging for worldwide use. For special applications, models with -48VDC, 24VDC, or 125VDC are available. Dual source DC input can also be selected and configured on the -48VDC, 24VDC, and 125VDC input models.

■ Extended Temperature Operation

The Magnum 4K16 has been tested for operation at temperatures of -5°C to 55°C. NEBS-certified models have been tested to a greater range per NEBS Level 3 requirements. For details, email mktg@garrettcom.com

2.4 Applications

Magnum 4K16 Switches offer high performance flexibility, and are easily used in a variety of applications including client/server computing, performance upgrades of departmental networks, and collapsed backbone applications. The Dual-Speed characteristic of the 4K16 Switches enables them to inter-connect a series of subnets (one subnet per 4K-Series Switch) in a LAN traffic center. The subnet connections may be via either optional fiber or twisted pair cabling, and may be 100Mbps or 10 Mbps speed and full-or half-duplex mode. The 16 ports switching capability of 4K16 allow to support a larger network with multiple workgroups.

The mixed-media capability is ideal for upgrading existing Ethernet LAN networks, where existing cabling must be accommodated. The fiber-built-in media capability is ideal for integrating future-proof fiber cabling into the LAN structure.

Example1: In general application, a Switch is needed to provide a Fast Ethernet departmental backbone. A switch is needed to provide a Fast Ethernet departmental LAN center requiring sixteen high speed LAN segments, at least 14 operating over 100Mbps full-duplex RJ-45 lines. In addition to interconnecting the two fiber backbone segments in the network center, the Switch needs to provide high-speed switched support for two central servers, for a connection to a router, and a combination of 10 and 100Mbps ports for a local workgroup of over a dozen users, printers, etc.

The Magnum 4K16 equipped with two optional Fiber port and 16 RJ-45 port modules provides an economical solution, configured with 16 switched ports (10/100 RJ-45) in a rack-mount box. The two Fiber FKM can be selected to provide any 100Mbps fiber media connector type desired.

This requirement for connecting local devices over twisted pair cabling is handled by the Magnum 4K16. With the optional Fiber-Port Module, a 2-port FKM, there is a switched port for distance and high bandwidth throughput to the remote department consisting of 4 users.

Since 100Mb fiber Ethernet has severe distance limitations at half-duplex, it is necessary in high speed backbones to operate fiber links in the full-duplex mode. Many low-end switches that only have RJ-45 N-way 10/100Mb ports would need to have a media converter on each fiber line. But most media converters do not support auto-negotiation and would not enable the fiber backbone lines to operate full-duplex. But the Magnum 4K16 . . . with two optional switched fiber ports at 100Mb speed, with full-

duplex mode as a default setting on fiber ports, and with some RJ-45 N-way 10/100Mb ports as well. . . handles this application readily.

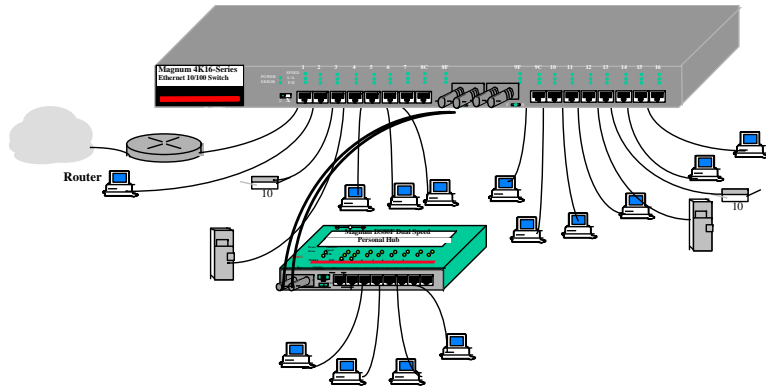

Figure 2.4a: The Magnum 4K16 provides a 10/100Mb backbone with high bandwidth facility in a department

Example 2: In another situation for a small office or a classroom, a central Switch is needed to provide for a 16-segment 100Mb Fast Ethernet backbone, with switched support for 2 high speed local file servers for different departments to share, and for 5 small office networks for each department along with their printer. In addition, the router connection for internet (WAN) and a couple of ports for future expansion are needed.

The Magnum 4K16 Switch, equipped with dual speed and switching capability per port, fits nicely in this environment and offers future fiber backbone expansion.

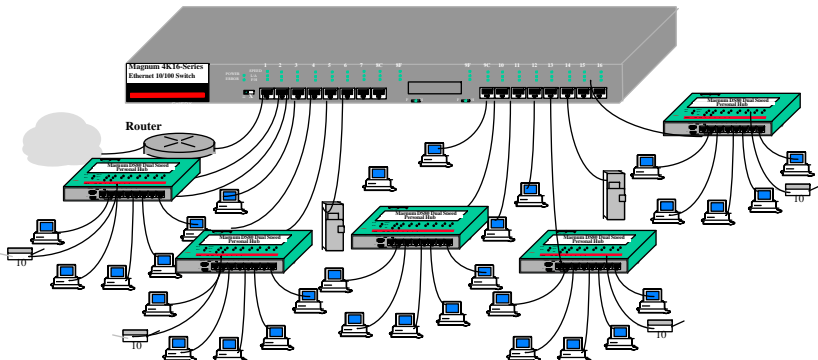

Fig. 2.4b: Magnum 4K16 Switch provides high bandwidth solution for small office or class room, offering expansion via “future-proof” fiber.

3.0 Installation

Before installing the equipment, it is necessary to take the following precautions:

- 1.) If the equipment is mounted in an enclosed or multiple rack assembly, the environmental temperature around the equipment must be less than or equal to 50°C.
- 2.) If the equipment is mounted in an enclosed or multiple rack assembly, adequate air flow must be maintained for proper and safe operation.
- 3.) If the equipment is mounted in an enclosed or multiple rack system placement of the equipment must not overload or load unevenly the rack system.
- 4.) If the equipment is mounted in an enclosed or multiple rack assembly, verify the equipment's power requirements to prevent overloading of the building/s electrical circuits.
- 5.) If the equipment is mounted in an enclosed or multiple rack assembly verify that the equipment has a reliable and uncompromised earthing path.
- 6.) If the intra-building wiring (cabling) is involved with this product (NEBS), then it is recommended to have shielded cable and the shield is grounded at both ends.

Installation: This section describes installation of the Magnum 4K-Series Switches, as well as connection of the various Ethernet media types.

3.1 Locating Magnum 4K16 Switches

The location of a Magnum 4K-Series Switch is dependent on the physical layout of the network. Typically the Switch is placed in a central wiring location where groups of network devices need to be connected in order to communicate with each other. These Switches are typically rack mounted in a wiring closet (see Section 3.3.2 below), but because they have rubber feet they can also be installed on a shelf or table top.

Locate an AC receptacle that is within six feet (2 meters) of the intended Magnum 4K-Series site. The rugged metal case of the Magnum 4K-Series will normally protect it from accidental damage in a lab or workplace setting. Maintain an open view of the front to visually monitor the status LEDs. Keep an open area around the unit so that cooling can occur from the small fan on the top of the silicon, while the unit is in operation. See figure below.

Figure 3.1: Location of 16-port Magnum 4K16's cooling fan air exhaust

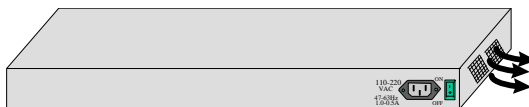

3.2 Connecting Ethernet Media

The Magnum 4K16 Switches are specifically designed to support all standard Ethernet media types within a single Switch unit. This is accomplished by complementing standard RJ-45 copper parts with a family of Fiber-port Modules (FKMs) which can be individually selected and configured per-port. See Section 2.4 for a description of the FKMs.

The various media types supported along with the corresponding IEEE 802.3 and 802.3u standards and connector types are as follows:

<u>IEEE Standard</u>	<u>Media Type</u>	<u>Max. Distance</u>	<u>Port Module</u>
<u>Fiber:</u>			
100BASE-FX	mm ¹ Fiber	2.0km (6,562 ft)	FKM-MSC, -MST
	sgl.m ² Fiber	20.0km (95K ft)	FKM-SSC
	sgl.m ² Fiber	40.0km (12K ft)	FKM-SSCL
small form factor	mm ¹ Fiber	2.0km (6,562 ft)	FKM-MTRJ,

Copper:

10BASE-T & 100BASE-TX twisted pair 100m (328 ft) RJ45

¹ mm = multi-mode

² sgl.m = single-mode

3.2.1 Connecting Fiber Optic **ST-type**, “twist-lock”

The following procedure applies to installations using a FKM with ST-type fiber connectors. This procedure applies to ports using a FKM-MST.

- Before connecting the fiber optic cable, remove the protective dust caps from the tips of the connectors on the FKM. Save these dust caps for future use.
- Wipe clean the ends of the dual connectors with a soft cloth or lint-free lens tissue dampened in alcohol. Make certain the connectors are clean before connecting.

Note: One strand of the duplex fiber optic cable is coded using color bands at regular intervals; you must use the color-coded strand on the associated ports at each end of the fiber optic segment.
- Connect the Transmit (TX) port (light colored post) on the Magnum FKM to the Receive (RX) port of the remote device. Begin with the color-coded strand of the cable for this first TX-to-RX connection.
- Connect the Receive (RX) port (dark colored post on the PM) to the Transmit (TX) port of the remote device. Use the non-color coded fiber strand for this.
- The LINK LED on the front of the FKM will illuminate when a proper connection has been established at both ends (and when power is ON in the unit). If LINK is not lit after cable connection, the normal cause is improper cable polarity. Swap the fiber cables at the FKM connector to remedy this situation.

3.2.2 Connecting Fiber Optic **SC-type, "Snap-In"**

The following procedure applies to installations using a FKM with SC-type fiber connectors, i.e., using FKM-MSC, FKM-SSC single-mode, and FKM10-MSC.

When connecting fiber media to SC connectors, simply snap on the two square male connectors into the SC female jacks of the FPM until it clicks and secures.

3.2.3 Connecting **Single-Mode** Fiber Optic

When using single-mode fiber cable, be sure to use single-mode fiber port connectors. Single-mode fiber cable has a smaller diameter than multi-mode fiber cable (9/125 microns for single-mode, 50/125 or 62.5/125 microns for multi-mode where xx/xx are the diameters of the core and the core plus the cladding respectively). Single-mode fiber allows full bandwidth at longer distances, and may be used to connect 100 Mb nodes up to 10 Km 18Km with the FKM-SSC and 40 Km with the FKM-SSCL.

The same procedures as for multi-mode fiber applies to single-mode fiber connectors. Follow the steps listed in Section 3.2.2 above.

3.2.4 Connecting **MTRJ** Fiber Optic "Snap-In"

The "MTRJ" is a multi-mode fiber connector considered as a "small form-factor", because of its small compact size. It looks almost like an RJ-45 port, but compact in size and black color. The MTRJ's small size and ease of connection make it a good choice for 100Mbps fiber environment. FKM-MTRJ fiber may be used to connect 100 Mb nodes up to 2 Km at full duplex and 412m at half-duplex.

When connecting fiber media to MTRJ connectors, simply snap in the square male connectors into the MTRJ female jacks of the FPM until it clicks and secures.

3.2.5 Connecting Twisted Pair (**RJ-45, CAT3, CAT5, Unshielded or Shielded**)

The RJ-45 ports of the Magnum 4K-Series can be connected to the following two media types: 100BASE-TX and 10BASE-T. CAT 5 cables should be used when making 100BASE-TX connections. When the ports are used as 10BASE-T ports, CAT 3 may be used. In either case, the maximum distance for unshielded twisted pair cabling is 100 meters (328 ft).

<u>Media</u>	<u>IEEE Standard</u>	<u>Connector</u>
Twisted Pair (CAT 3, 4, 5)	10BASE-T	RJ-45
Twisted Pair (CAT 5)	100BASE-TX	RJ-45

NOTE : *It is recommended that high quality CAT. 5 cables (which work for both 10 Mb and 100Mb) be used whenever possible in order to provide flexibility in a mixed-speed network, since dual-speed ports are auto-sensing for either 10 and 100Mb/s.*

The following procedure describes how to connect a 10BASE-T or 100BASE-TX twisted pair segment to the RJ-45 port. The procedure is the same for both unshielded and shielded twisted pair cables.

1. Using standard twisted pair media, insert either end of the cable with an RJ-45 plug into the RJ-45 connector of the port. Note that, even though the connector is shielded, either unshielded or shielded cables and wiring may be used.
2. Connect the other end of the cable to the corresponding device
3. Use the LINK LED to ensure proper connectivity by noting that the LED will be illuminated when the unit is powered and proper connection is established.

3.3 Rack-mounting

Installation of a Magnum 4K16 Switch in a 19" rack is a simple

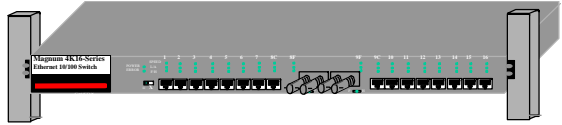

procedure. The units are 1U (1.70") high. When properly installed, the front-mounted LED status indicators should be in plain view and easy to read. Rack-mount installation requires special 19" rack-mounted brackets and screws (included with each 4K16 unit). The brackets attach to the front sides of the Switch, which is then fastened into a standard 19" RETMA rack.

The 23" brackets and ETSI brackets are also available (optional) for rack-mounting of Magnum 4K Series Switches. The 23" brackets are popular in the Telco industry where they are a standard for Central Office rack mounting purposes. The 23" brackets are mainly being used for larger equipment assemblies in rack-mounting frames, and are frequently accessed in operation from both sides.

The ETSI (European Telephone Standard) brackets are similar to the 19" brackets but use metric dimensions.

The optional 23" brackets and the ETSI brackets come as a pair in a package, along with the necessary screws for attaching the brackets to the sides of the Magnum Switch unit.

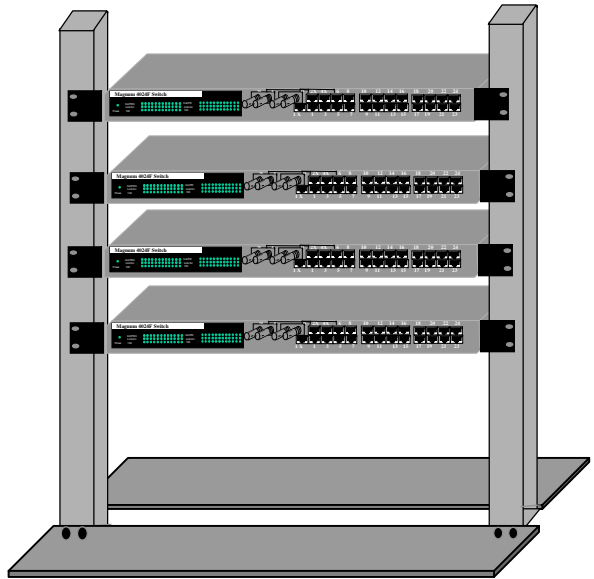

Fig 3.3 Multiple Magnum 4K16 units rack-mounted in a 23" Rack-mount frame

4.0 OPERATION

This chapter describes the functions and operation of the 4K-Series.

4.1 Switching Functionality

A Magnum 4K-Series provides switched connectivity at Ethernet wire-speed among all of its ports. They support 10/100Mbps for copper media and 10 or 100Mb separate traffic domain for fiber port to maximize bandwidth utilization and network performance. All ports can communicate to all other ports in a Magnum 4K-Series, but local traffic on a port will not consume any of the bandwidth on any other port.

Magnum 4K-Series units are plug-and-play devices. There is no software or jumper settings (hardware) configuring to be done at installation or for maintenance. The internal functions are described below.

Filtering and Forwarding

Each time a packet arrives on one of the switched ports, the decision is taken to either filter or to forward the packet. Packets whose source and destination addresses are on the same port segment will be filtered, constraining them to that one port and relieving the rest of the network from processing them. A packet whose destination address is on another port segment will be forwarded to the appropriate port, and will not be sent to the other ports where it is not needed. Traffic needed for maintaining the operation of the network (such as occasional multi-cast packets) is forwarded to all ports.

The Magnum 4K-Series Switches operate in the store-and-forward switching mode, which eliminates bad packets and enables peak performance to be achieved when there is heavy traffic on the network.

Address Learning

All 16-port Magnum 4K-Series units have address table capacity of 4K node addresses, suitable for use in large networks. They are self-learning, so that as nodes are added or removed or moved from one segment to another, the 4K16-Port Switch automatically keeps up with node locations.

An address-aging algorithm causes least-used addresses to fall out in favor of new frequently-used addresses. To reset the address buffer, cycle power down-and-up.

4.2 Status LEDs

For Magnum 4K16 models :

- PWR** : Power LED, ON when external power is applied to the unit.
- L/A** : Steady ON for link with no traffic, blinking indicates port is transmitting and receiving.
- F/H** : Full / Half duplex LED, steady ON when the port is running full duplex, blinking for half duplex collisions
- Speed** : Speed LED, ON when the speed is 100Mbps , OFF when the speed is 10 Mbps.

4.3 Up-link Switch, for RJ-45 Port#1 only



Figure 4.3 : Up-link switch on RJ-45 Port#1

Magnum 4K16s each have one Up-link manual switch next to port #1 which it controls, can be used while cascading with other hub switch or any communicating device. The Up-link switch allows repeater-to-repeater connections without a special cross-over cable. It works the same for 10Mb or 100Mb connections.

Move sliding switch to “=” (or ports 2 thru 16) for straight-through twisted pair cabling from the 4K16 switched port to a user device, or to “X” for cross-over or up-link segment connections from the first 4K16 port to a repeater or hub or switch. Verify proper port connection by noting the port’s LINK/ACT status, which is illuminated when a proper link is made and blinking when there is activity.

4.4 Auto-negotiation, for Fast Ethernet copper ports

One frequently-used application for the Magnum 4K16 Switch copper ports is to connect one of them using a fiber media converter to another Switch in the network backbone, or to some other remote 100Mb device. In this case, it is desirable to operate the fiber link at 100Mb speed, and at either half- or full duplex mode depending on the capabilities of the remote device. Standard commercially-available Fast Ethernet media converters mostly do not support auto-negotiation properly, and require that the switched port to which they are connected be at 100Mb fixed speed. Attachment to 10/100 auto-negotiation ports typically will not work properly

When 4K16 Switch’s RJ-45 copper ports are set for auto-negotiation and

connected to an another auto-negotiating device, there are 4 different speed and F/H modes selection depending on what the other device supports. These are: (1) 100Mb full-duplex, (2) 100Mb half-duplex, (3) 10 Mb full-duplex and (4) 10 Mb half-duplex. The auto-negotiation logic will attempt to operate in descending order and will normally arrive at the highest order mode that both devices can support at that time. (Since auto-negotiation is potentially an externally-controlled process, the original “highest order mode” result can change at any time depending on network changes that may occur). If the device at the other end is not an auto-negotiating device, the 4K16-Switch’s RJ-45 ports will try to detect its idle signal to determine 10 or 100 speed, and will default to half-duplex at that speed per the IEEE standard.

General information -

Auto-negotiation per-port for 802.3u-compliant switches occurs when:

the devices at both ends of the cable are capable of operation at either 10 Mb or 100Mb speed and/or in full- or half-duplex mode, and can send/receive auto-negotiation pulses, and . . .

- when the second of the two connected devices is powered up*, i.e., when LINK is established for a port, or
- when LINK is re-established on a port after being lost temporarily.

- **NOTE – *some NIC cards only auto-negotiate when the computer system that they are in is powered up. These are exceptions to the “negotiate at LINK – enabled” rule above, but may be occasionally encountered.***

When operating in 100Mb half-duplex mode, cable distances and hop-counts may be limited within that collision domain. The Path Delay Value (PDV) bit-times must account for all devices and cable lengths within that domain. For Magnum 4K-Series Fast Ethernet switched ports operating at 100Mb half-duplex, the bit time delay is 50BT.

4.5 Auto-negotiation full-duplex mode

Full-duplex Ethernet provides separate Transmit and Receive data paths, enabling simultaneous bi-directional collision-free data movements on a port. The network topology must be a “star” type, not a “bus” type. With full-duplex mode, the cable distance is only limited by the physical layer line driver and cable attenuation.

There are no collision-domain restrictions or limitations.

The Magnum 4K-Series Switches perform half- or full-duplex mode auto-negotiation independently on all switched ports. If the device or node on the other end of a port's attached cable supports auto-negotiation or is set to operate as full-duplex, the Magnum 4K16 Switch will negotiate to run full-duplex. If the attached device or node doesn't support F/H mode or fixed at Full or Half duplex (for example, if it is a 10 Mb repeater or a standard 10 Mb hub or older Switch with Fixed full duplex mode), the 4K16-Switch's RJ-45 ports will default to operate at half-duplex.

4.6 Flow-control, IEEE 802.3x standard

Magnum 4K- Series Switches incorporate a flow-control mechanism for Full-Duplex mode. The purpose of flow-control is to reduce the risk of data loss if a long burst of activity causes the switch to save frames until its buffer memory is full. This is most likely to occur when data is moving from a 100Mb port to a 10 Mb port, and the speed difference makes the 10Mb port unable to keep up. It can also occur when multiple 100Mb ports are attempting to transmit to one 100Mb port, and in other protracted heavy traffic situations.

Magnum 4K-Series Fiber Switches implement the 802.3x flow control (non-blocking) on Full-Duplex ports, which provides for a "PAUSE" packet to be transmitted to the sender when the packet buffer is nearly filled and there is danger of lost packets. The transmitting device is commanded to stop transmitting into the switched port for sufficient time to let the Switch reduce the buffer space used. When the available free-buffer queue increases, the Switch will send a "RESUME" packet to indicate the transmitter to start sending the packets. Of course, the transmitting device must also support the 802.3x flow control standard in order to communicate properly during normal operation.

Note: When in Half-Duplex mode, the 4K16-switch implements a back-pressure algorithm on 10/100 Mb ports for flow control. That is, the switch prevents frames from entering the device by forcing a collision indication on the half-duplex ports that are receiving. This temporary "collision" delay allows the available buffer space to improve, as the switch catches up with the traffic flow.

4.7 Power Budget Calculations for 4K-Series FKM's with Fiber Media

Receiver Sensitivity and Transmitter Power are the parameters necessary to compute the power budget. To calculate the power budget of different fiber media installations using Magnum products, the following equations should be used:

$$\text{OPB (Optical Power Budget)} = P_T(\text{min}) - P_R(\text{min})$$

where P_T = Transmitter Output Power, and P_R = Receiver Sensitivity

Worst case OPB = OPB - 1dB(for LED aging) - 1dB(for insertion loss)

Worst case distance = {Worst case OPB, in dB} / [Cable Loss, in dB/Km]
 where the “Cable Loss” for 62.5/125 and 50/125 μ m (M.m) is 2.8 dB/km,
 and the “Cable Loss” for 100/140 (Multi-mode) is 3.3 dB/km,
 and the “Cable Loss” for 9/125 (Single-mode) is 0.5 dB/km

The following data has been collected from component manufacturer’s (HP’s and Siemens’) web sites and catalogs to provide guidance to network designers and installers.

Fiber Port Module	Speed, Std.	Mode	Std. km fdx (hdx)	Wave - length nm	Cable Size μ m	X'mitr Output P _T , dB	R'cvr Sens. P _R , dB	Worst OPB, dB	Worst* distance Km, fdx	typical OPB, dB	typical* distance Km, fdx
FKM-MST, MSC	100Mb FX	Multi-mode	2 (0.4)	1300	62.5/125	-20	-31	9.0	2.5	14	5
					50/125	-23.5	-31	5.5	2.0	12	4
FKM-SSC	100Mb FX	Single-mode	18+ (0.4)	1300	9/125	-15	-31	14	28	17.5	35
FKM-MTRJ	100Mb FX	Multi-mode	2 (0.4)	1300	62.5/125	-20	-31	9.0	3.0	15.8	5.5
					50/125	-23.5	-31	5.5	2.0	12.2	4.0
FKM-SSCL	100Mb FX	Single-mode	40 (0.4)	1300	9/125	-5	-34	29	58	32.5	65

* **Note:** The use of either multi-mode or single-mode fiber to operate at 100Mbps speed over long distances (i.e., in excess of approx. 400 meters) can be achieved **only** if the following factors are both applied:

- The 100Mb fiber segment must operate in full-duplex (FDX) mode, i.e. the full-duplex (factory default) setting for 100Mbps fiber ports must be used, and
- The worst-case OPB of the fiber link must be greater than the fiber cable’s passive Attenuation.

(Attenuation = Cable loss + LED aging loss + Insertion loss + safety factor)

5.0 Introduction - Magnum 4K16 Fiber-Port Modules (FKM)

This chapter describes each Fiber-Port Module (FKM), including appearance, functionality, and status displays

5.1 Product Description

An important feature of the Magnum 4K-Series is the use of Fiber-Port Modules (FKMs) for flexible mixed-media connectivity to RJ-45 and fiber media. Since the Magnum 4K-Series Switches have dual-speed capability for copper ports, the copper port interfaces are designed to support all standard Ethernet media types at 100Mbps speed. Each FKM provides one port for connecting Ethernet segments with its individual connector type and media.

For a list of Fiber-Port Module types, refer to Section 1.2

Each FKM is individually described in the following sections.

NOTE: The Fiber Module option are offered as Factory installation only and will be added as additional two ports (16RJ-45 + 2 Fiber ports).

5.1.1 FKM-MST, 100Mbps multi-mode FX-ST-type, “twist-lock” connector

The Magnum FKM-MST is a multi-mode 100Mbps fiber optic module equipped with a dual ST-type connector. It functions as a fiber optics transceiver to support 100BASE-FX network segments. When installed in a Magnum 4K16 Full-duplex Switch, it supports fiber optic cable distances up to the IEEE-specified switch distance limits, i.e., typically 2000 meters.

100BASE-FX, FKM-2ST Connectors

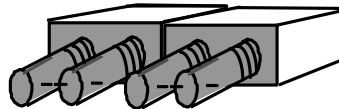

5.1.2 FKM-MSC 100Mbps multi-mode FX-SC-type, “snap-in” connector

The Magnum FKM-MSC is also a multi-mode 100Mbps fiber optic transceiver module, similar to the FKM-MST.

100BASE-FX, FKM-2SC Connectors

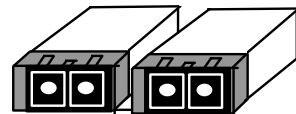

While the functionality of the these two modules is the same, the FKM-MSC is equipped with an SC-type “snap-in” connector instead of an ST-type.

5.1.3 FKM-SSC and –SSCL 100Mbps single-mode FX-SC-type, “snap-in”

The Magnum FKM-SSC (and –SSCL) is a single-mode 100Mbps fiber optic

module equipped with a dual SC-type connector. It functions as a full fiber optic transceiver to support single-mode fiber networks.

To distinguish the single-mode FPM-SSC from the multi-mode FKM-MSD, the label “Sgl. M.” is at the top of the faceplate of the FKM-SSC.

5.1.4 FKM-MTRJ, 100Mb multi-mode FX, MTRJ small-form-factor connector

Magnum FKM-MTRJ is a multi-mode fiber optic module equipped with a small-form-factor MTRJ-type connector. It looks almost like an RJ-45 port, but it is black plastic in color. The MTRJ's small size and ease of

100BASE-FX, Small Form Factor FKM-2MTRJ Connectors

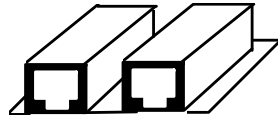

connection make it a good choice for 100Mbps Ethernet connectivity. When installed in a Magnum 4K16 Full-duplex Switch, it supports fiber optic cable distances up to the IEEE-specified switch distance limits, i.e., typically 2000 meters.

The functionality of this 100BASE-FX multi-mode FKM-MTRJ is the same as the ST and SC-types. Note that the other end of the fiber cable may have a different connector, not necessarily an MTRJ type.

5.1.5 FKM-Blank

The FKM-Blank is a blank face plate that must be installed in any empty FKM slot. When the Magnum 4K16 chassis contains less than two front-mounted FKMs, the empty front slots must be covered with the FKM-Blank face plate in order to maintain proper cooling air flow, and for safety, etc.



Note: The FKM-Blank must be installed in each empty PM slot.

FKM-Blank

6.0 TROUBLESHOOTING

All Magnum Ethernet products are designed to provide reliability and consistently high performance in all network environments. The installation of Magnum 4K16 Series Switches is a straightforward procedure (see INSTALLATION, Section 2.6); the operation is also straightforward and is discussed in Section 4.

Should problems develop during installation or operation, this section is intended to help locate, identify and correct these types of problems. Please follow the suggestions listed below prior to contacting your supplier. However, if you are unsure of the procedures described in this section or if the Magnum 4K16 Series Switch is not performing as expected, do not attempt to repair the unit; instead contact your supplier for assistance or contact GarrettCom Customer Support.

6.1 Before Calling for Assistance

1. If difficulty is encountered when installing or operating the unit, refer back to the Installation Section of the applicable chapter of this manual. Also check to make sure that the various components of the network are interoperable.
2. Check the cables and connectors to ensure that they have been properly connected and the cables/wires have not been crimped or in some way impaired during installation. (About 90% of network downtime can be attributed to wiring and connector problems.)
3. Make sure that an AC power cord is properly attached to each Magnum 4K16 unit. Be certain that each AC power cord is plugged into a functioning electrical outlet. Use the PWR LEDs to verify each unit is receiving power.
4. If the problem is isolated to a network device other than the Magnum 4K16 product, it is recommended that the problem device is replaced with a known good device. Verify whether or not the problem is corrected. If not, go to Step 5 below. If the problem is corrected, the Magnum 4K16 Series Switches and its associated cables are functioning properly.
5. If the problem continues after completing Step 4 above, contact your supplier of the Magnum 4K16 unit or if unknown, contact GarrettCom, Inc. by fax, phone or email (support@garrettcom.com) for assistance.

6.2 When Calling for Assistance

Please be prepared to provide the following information.

1. A complete description of the problem, including the following points:
 - a. The nature and duration of the problem;
 - b. Situations when the problem occurs;
 - c. The components involved in the problem;
 - d. Any particular application that, when used, appears to create the problem;
2. An accurate list of GarrettCom product model(s) involved, with serial number(s). Include the date(s) that you purchased the products from your supplier.
3. It is useful to include other network equipment models and related hardware, including personal computers, workstations, terminals and printers; plus, the various network media types being used.
4. A record of changes that have been made to your network configuration prior to the occurrence of the problem. Any changes to system administration procedures should all be noted in this record.

6.3 Return Material Authorization (RMA) Procedure

All returns for repair must be accompanied by a Return Material Authorization (RMA) number. To obtain an RMA number, please use this URL -

https://rma.garrettcom.com/rma/rma_request_noaccount.php to fill out the form.

Please have the following information readily available:

Name and phone number of your contact person.

Name of your company / institution

Your shipping address

Product name

Serial Number (or Invoice Number)

Packing List Number (or Sales Order Number)

Date of installation

Failure symptoms, including a full description of the problem.

GarrettCom will carefully test and evaluate all returned products, will repair products that are under warranty at no charge, and will return the warranty-repaired units to the sender with shipping charges prepaid (see Warranty Information, Appendix A, for complete details). However, if the problem or condition causing the return cannot be duplicated by GarrettCom, the unit will be returned as:

No Problem Found.

GarrettCom reserves the right to charge for the testing of non-defective units under warranty. Testing and repair of product that is not under warranty will result in a customer (user) charge.

6.4 Shipping and Packaging Information

Should you need to ship the unit back to GarrettCom, please follow these instructions:

1. Package the unit carefully. It is recommended that you use the original container if available. Units should be wrapped in a "bubble-wrap" plastic sheet or bag for shipping protection. (You may retain all connectors and this Installation Guide.)

CAUTION: Do not pack the unit in Styrofoam "popcorn" type packing material. This material may cause electro-static shock damage to the unit.

2. Clearly mark the Return Material Authorization (RMA) number on the outside of the shipping container.
3. GarrettCom is not responsible for your return shipping charges.
4. Ship the package to:

**GarrettCom, Inc.
47823 Westinghouse Dr.
Fremont, CA 94539
Attn.: Customer Service**

APPENDIX A: WARRANTY INFORMATION

GarrettCom, Inc. warrants its products to be free from defects in materials and workmanship for a period of three (3) years from the date of shipment by GarrettCom.

During this warranty period, GarrettCom will repair or, at its option, replace components in the products that prove to be defective at no charge other than shipping and handling, provided that the product is returned pre-paid to GarrettCom.

This warranty will not be effective if, in the opinion of GarrettCom, the product has been damaged by misuse, misapplication, or as a result of service or modification other than by GarrettCom.

GarrettCom reserves the right to make a charge for handling and inspecting any product returned for warranty repair which turns out not to be faulty.

Please complete the warranty card as this acts as a product registration, and mail it to GarrettCom within two weeks of your purchase.

APPENDIX B : INTERNAL DC POWER SUPPLY OPTIONS**B1.0 SPECIFICATIONS - FOR MAGNUM 4K16 DC-POWERED SWITCHES****Power Supply (Internal -48VDC Option)**

DC Power Connector: 3 terminals: “-“, “GND”, “+”

Input Voltage: 36 - 70 VDC

Power Consumption: Model 4K16: 17 watt typical, 25 watts max.

Power Supply (Internal 24 VDC Option) Industrial Application

DC Power Connector: 3 terminals: “-“, “GND”, “+”

Input Voltage: 20 - 36 VDC

Power Consumption: Model 4K16: 17 watt typical, 25 watts max.

Power Supply (Internal 125 VDC Option) Industrial Application

DC Power Connector: 3 terminals: “-“, “GND”, “+”

Input Voltage: 120 - 160 VDC

Power Consumption: Model 4K16: 17 watt typical, 25 watts max.

With the exception of the power supply, all specifications and functions of Magnum 4K-Series-48VDC, 24VDC and 125VDC models are identical to those listed in the main manual.

B2.0-48VDC, 24VDC & 125VDC POWER OPTION, THEORY OF OPERATION

The -48VDC, 24VDC & 125VDC power option are designed using diodes inside on each DC power input line behind the two external power connection terminals, so that the power from an external

source can only flow into the hub.

This allows the Switch to operate only

whenever DC power is correctly applied to the two inputs. It protects

the Switch from incorrect DC input connections. An incorrect polarity connection, for example, will neither affect the Switch, its internal power supply, nor will it blow the fuse in the internal power supply.

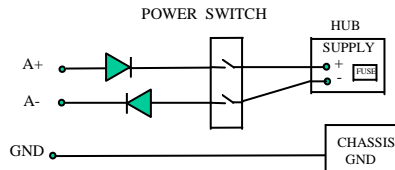

The manual power “On-Off” Switch (optional) is used for powering the unit on and off when it is placed into or taken out of service.

B3.0 APPLICATIONS FOR DC POWERED SWITCHES

Magnum 4K-Series Fiber Switches are easily installed in a variety of applications where -48VDC, 24VDC & 125VDC power is used as the primary power source. The -48VDC, 24VDC & 125VDC power configuration provides an Ethernet networking solution utilizing a special power supply in hubs with a proven track record.

The -48VDC solution is particularly useful in the telecommunication industry, where it is common for facilities to operate on -48VDC power. Such companies include

regular and wireless telephone service providers, Internet Service Providers (ISPs) and other communication companies. In addition, many high availability equipment services, such as broadcasters, publishers, newspaper operations, brokerage firms and other facilities often use a battery backup system to maintain operations in the event of a power failure. It is also frequently used for computer system backup, management and operations monitoring equipment.

The 24VDC and 125VDC solution are particularly useful in the Industrial environment, where it is common for facilities to operate on 24VDC or 125VDC power. The 125VDC solution is mainly used in Utilities Industries, such as Electric substation, Electrical generating plant etc. Whereas 24VDC application is mainly in the Industrial environment, such as chemical plants, paper mill, stone quarrying plant, wastewater treatment Plant etc.

B4.0 INSTALLATION

This section describes the installation of the -48 VDC, 24VDC & 125VDC power source leads to the -48 VDC, 24VDC & 125VDC power terminal block on the Magnum Ks. (see figure at the right).

In this picture, the -48VDC terminal block on the Magnum 4Ks is located on the rear of the unit and is equipped with three (3) screw-down lead posts. It is similar for 24VDC and 125VDC options on Magnum 4Ks. The leads are identified as negative (-), positive (+), and chassis ground (GND).

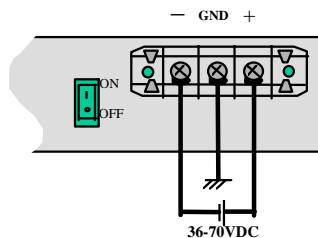

Figure B4.1: -48VDC Terminal Block on Magnum Ks-48VDC

The actual connection procedure is straightforward. Simply connect the leads to the Magnum unit, beginning with ground. Ensure that each lead is securely tightened.

Note: The GND should be hooked up first. The 4K unit has a floating ground, so the user may elect to Ground either + or = terminal to suit the customer's use.

Before connecting hot lines to the Terminal Block of -48VDC, 24VDC or 125VDC, always use a digital voltmeter to measure the output voltage of the power supply and determine the lead which is more "+ve potential". The more "+ve" voltage lead from 48V or -48V supply must be connected to the post labeled "+".

An ON-OFF manual switch is optional for DC power. This can be used to cut off power connections and as a RESET for the 4K-Series Switch.

B4.1 UL Requirements

1. Minimum 14 AWG cable for connection to a Centralized DC power source.
2. Fastening torque of the lugs on the terminal block: 9 inch pound max.
3. Centralized DC Power Source cable securement, use at least four cable ties to

secure the cable to the rack at least 4 inches apart with the first one located within 6 inches of the terminal block.

B5.0 OPERATION

Operation of the Magnum Ks with the optional -48VDC, 24VDC & 125VDC power supply is identical to that of the standard AC-powered models.

B6.0 ORDERING INFORMATION

To order the optional -48VDC power supply factory installed, add a suffix of “-48VDC” after the product’s standard model #. Example: **Magnum 4K16-48VDC**.

Similarly, to order the optional 24VDC or 125VDC industrial specific power supply factory installed, add a suffix of “24VDC” or “125VDC” after the product’s standard model #. Example: **Magnum 4K16-24VDC** or **Magnum 4K16-125VDC**.

B7.0 TROUBLESHOOTING

Please refer to Section 6.0 for troubleshooting

APPENDIX D: INTERNAL DC DUAL-SOURCE POWER OPTION

C1.0 SPECIFICATIONS - FOR MAGNUM 4K-SERIES FIBER SWITCH

Power Supply (Internal, -48VDC Dual-Source, model # Dual-Src-48V)

DC Power Connector: First Source: “A+”, “A-“, 2nd Source “B-“, “B+”

GND: Terminal for “earth” or ground wire connection to the hub chassis

Input: Two separate sources, each at 36 - 70 VDC

Power Consumption: Model -4K16: 17 watt typical, 25 watts max.

Power Supply (Internal, 24VDC Dual-Source, model # Dual-Src-24V)

DC Power Connector: First Source: “A+”, “A-“, 2nd Source “B-“, “B+”

GND: Terminal for “earth” or ground wire connection to the hub chassis

Input: Two separate sources, each at 20 - 36 VDC

Power Consumption: Model -4K16: 17 watt typical, 25 watts max.

Power Supply (Internal, 125VDC Dual-Source, model # Dual-Src-125V)

DC Power Connector: First Source: “A+”, “A-“, 2nd Source “B-“, “B+”

GND: Terminal for “earth” or ground wire connection to the hub chassis

Input: Two separate sources, each at 120 - 160 VDC

Power Consumption: Model -4K16: 17 watt typical, 25 watts max.

With the exception of the dual DC input power connections and the power supply, all specifications and configuration options for the Magnum 4K16 -48VDC, 4K16-24VDC & 125VDC with this Dual-Source option are identical to those listed in the *Magnum 4K-Series Fiber Switches Installation and User Guide*, including Appendix B “Internal DC Power Supply Option”

C2.0 MAGNUM 4K-SERIES , with -48VDC, 24VDC & 125VDC Dual-Source option

The 4K16-Switch models with the internal -48VDC, 24VDC & 125VDC Dual-

Source power supply are designed for installations where a battery plant is the power source, and where two separate power sources are utilized in order to increase operational uptime and to simplify maintenance.

The functionality of the Magnum 4K-Series -48VDC, 24VDC & 125VDC Dual-Source Option units are identical to the standard AC-powered models. Refer to the main sections of this *Installation and User Guide* for a detailed description of the Magnum 4K-Series Switches.

C3.0 DUAL-SOURCE OPTION, THEORY OF OPERATION

The Dual-Source DC power option is designed using diodes inside of the chassis on each DC power input line. A diode is placed in each of the four input lines (behind the four external power connection terminals) so that power from an external source can only flow into the unit. This allows the unit to operate whenever DC power is correctly applied to either or both of the two inputs

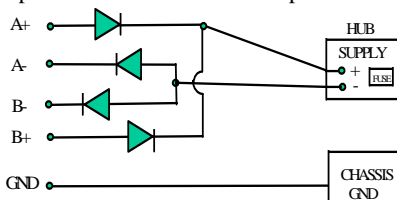

C4.0 FEATURES AND BENEFITS OF THE DUAL-SOURCE DESIGN

- The Switch unit can receive power from either input, "A" or "B". The hub will normally draw its power from the DC source with the highest voltage at a given time.
- The Switch unit will not allow power to flow from a higher voltage input to a lower voltage input, i.e. the two DC power sources are not mixed together by the hub.
- When one correct DC input is present, the Switch will receive power if the other DC input is absent, or even if it is connected with reverse polarity or shorted or grounded.
- Reverse polarity connections, if they should accidentally occur on either input, will not damage the Switch or power supply internally (nor will it blow the fuse in the internal power supply) because of the blocking action of the diodes. This is true even if one input connection is reversed while the Switch is operating from the other source.
- The Switch will not receive power (and will not work) when both inputs are simultaneously absent or are both incorrectly connected.

C5.0 INSTALLATION

This section describes the proper connection of the -48VDC, 24VDC & 125VDC dual source leads to the -48VDC, 24VDC and 125VDC power terminal block on the Magnum 4K-Series Switch (shown in Figure)

The -48VDC terminal block on the Magnum 4K-Series Switch is located on the right rear of the unit and is equipped with five (5) screw-down lead posts (see Fig C5.0). The primary terminals are identified as positive (A+), negative (A-), and the secondary power terminals as negative (B-), positive (B+). The chassis "earth" or ground (GND), is a threaded post with a #6 nut.

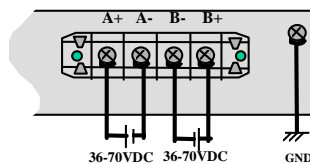

Figure C5.0: -48VDC Dual-Source, wiring connections to the External Terminal Block on a Magnum 48VDC with Dual-Source option

Note: The GND should be hooked up first. The 4K unit has a floating ground, so the user may elect to Ground either + or - terminal to suit the customer's use.

Before connecting to Terminal block of -48VDC, 24VDC or 125VDC, always use a digital voltmeter to measure the output voltage of the power supply and determine the lead which is more “+ve potential”. The more “+ve” voltage lead from 48V or -48V supply must be connected to the post labeled “+”.

The connection procedure is straightforward. Simply connect the DC leads to the Switch’s power terminals, positive (+) and negative (-) screws. The use of Ground (GND) is optional; it connects to the chassis. Ensure that each lead is securely tightened. The 24VDC & 125VDC terminal block on Magnum 4K-Series Switch also has everything similar to -48VDC info. Described above.

C5.1 UL Requirements

The following must be adhered to in order to conform to UL requirements:

1. *Minimum 14 AWG cable for connection to a Centralized DC power source.*
2. *Fastening torque of the lugs on the terminal block: 9 inch pound max.*
3. *Centralized DC Power Source cable securement, use at least four cable ties to secure the cable to the rack at least 4 inches apart with the first one located within 6 inches of the terminal block.*

C6.0 ORDERING INFORMATION

To order the optional Dual-Source -48VDC power supply factory installed, order “Dual-Src48V” as a separate line item following the product model.

Example: **Magnum 4K16-48VDC**

Dual-Src-48V for regular model with no ON-OFF switch

Or **Dual-Src48V-SWITCH** for model with ON-OFF switch

Similarly, order “Dual-Src24V” or “Dual-Src125V” as a separate line item following the product model.

Example: **Magnum 4K16-24VDC** or **Magnum 4K16-125VDC**

Dual-Src24V for regular model with no ON-OFF switch

Dual-Src24V-SWITCH for model with ON-OFF switch

C7.0 OPERATION

Operation of the Dual-Source Magnum 4K-Series-48VDC, 24VDC & 125VDC Switch models are identical to that of the standard models.